

pholc

OUR COLLECTIONS

Proudly Distributed by

IMDC
IM DESIGN CONCEPTS

A Swedish design statement



METER

A floor lamp collection



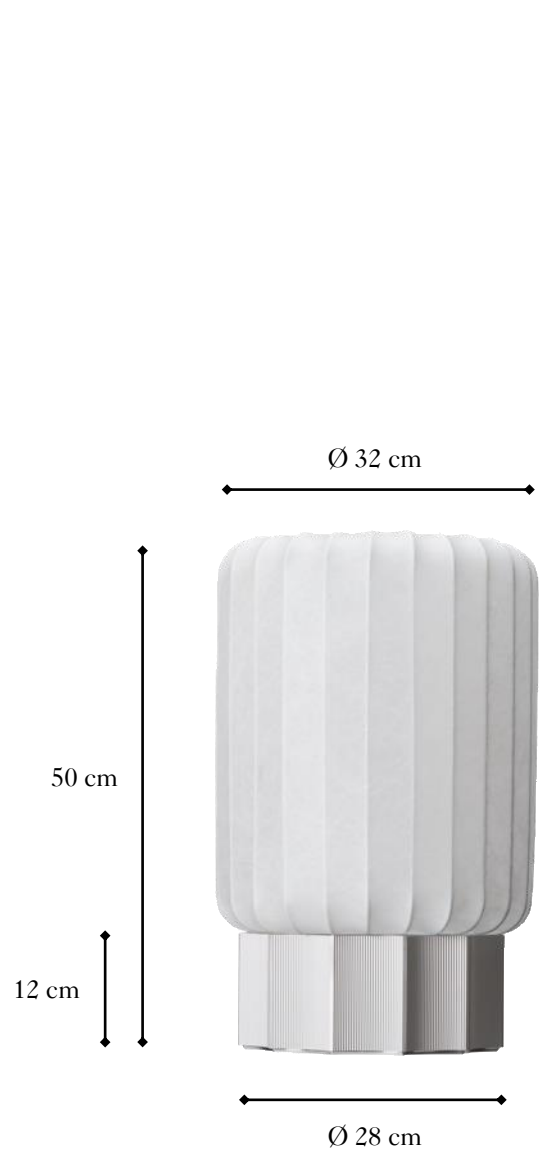

HALF METER



ONE METER

SPECIFICATIONS

DESIGN Maria Bruun and Anne Dorthe Vester

MATERIAL Cocoon, aluminium

COLOUR Cocoon, aluminium

More information One Meter [[link](#)]

More information Half Meter [[link](#)]

Download Meter files [[link](#)]





APOLLO

A pendant and floor lamp collection

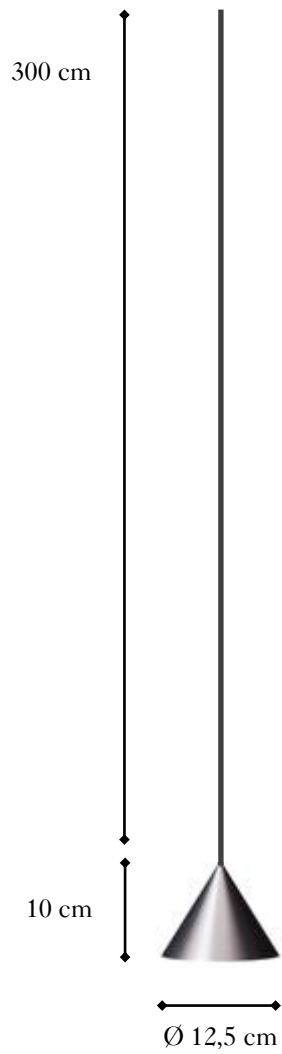

APOLLO ZERO

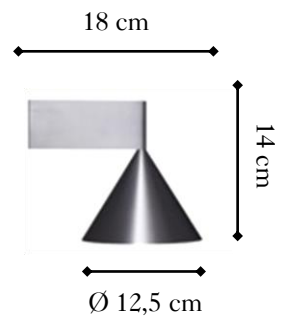

APOLLO 14

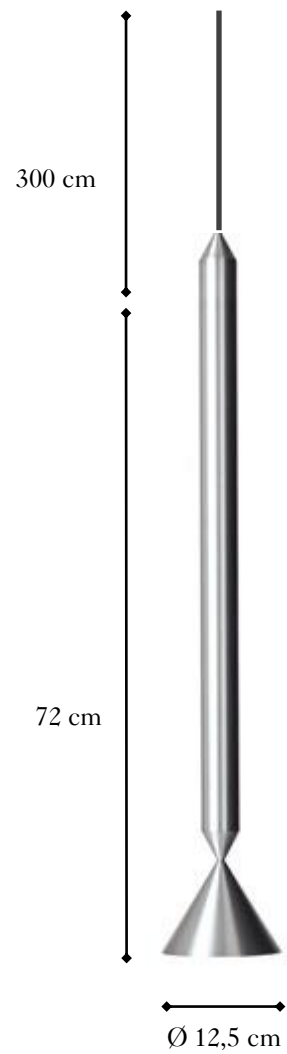

APOLLO 59

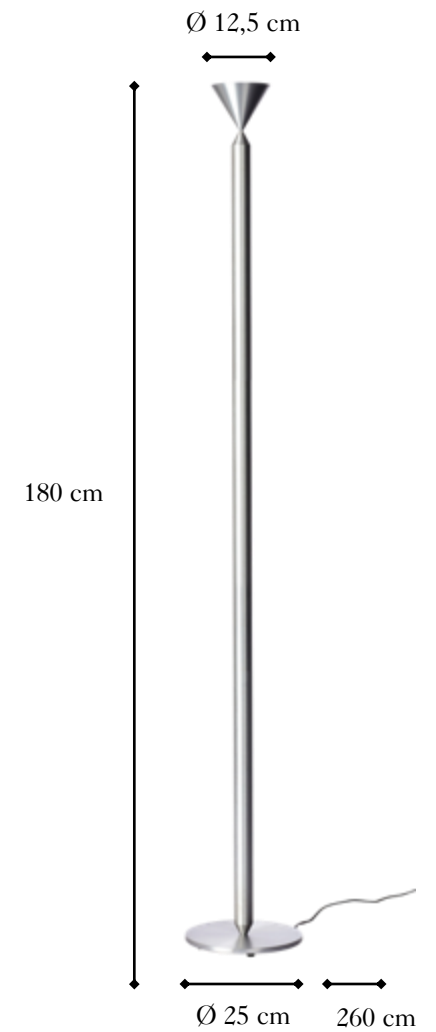

APOLLO 180

APOLLO ZERO

MOUNTING Ceilingcup

MATERIAL Aluminium

COLOUR Aluminium, Darkest Hour

SOCKET GU10

DIMENSION D:13 H:10 W:10

HOW TO USE Co-working spaces, restaurants
hotel lobbies and other hospitality
spaces. Home setting kitchen or
living room



APOLLO 14

MOUNTING	Upwards or downwards. Fixed installation
MATERIAL	Aluminium
COLOUR	Aluminium, Darkest Hour
SOCKET	GU10
DIMENSION	D:18 H:14 W:13
SPAREPARTS	Mountingplate EU Mountingplate US
HOW TO USE	Co-working spaces, restaurants hotel lobbies and other hospitality spaces. Home setting hallway or staircase.



APOLLO 59

MOUNTING Ceilingcup

MATERIAL Aluminium

COLOUR 5 colours

SOCKET GU10

DIMENSION D:13 H:72 W:13

HOW TO USE Co-working spaces, restaurants
hotel lobbies and other hospitality
spaces. Home setting kitchen or
living room





TURTLEDOVE

RED ORANGE

CUMIN

ALUMINIUM

DARKEST HOUR

APOLLO 180

MOUNTING	Cable type
MATERIAL	Aluminium
COLOUR	Aluminium
SOCKET	GU10.
DIMMER	YES
DIMENSION	D:25 H:180
HOW TO USE	Living rooms, hotel lobbies and lounges

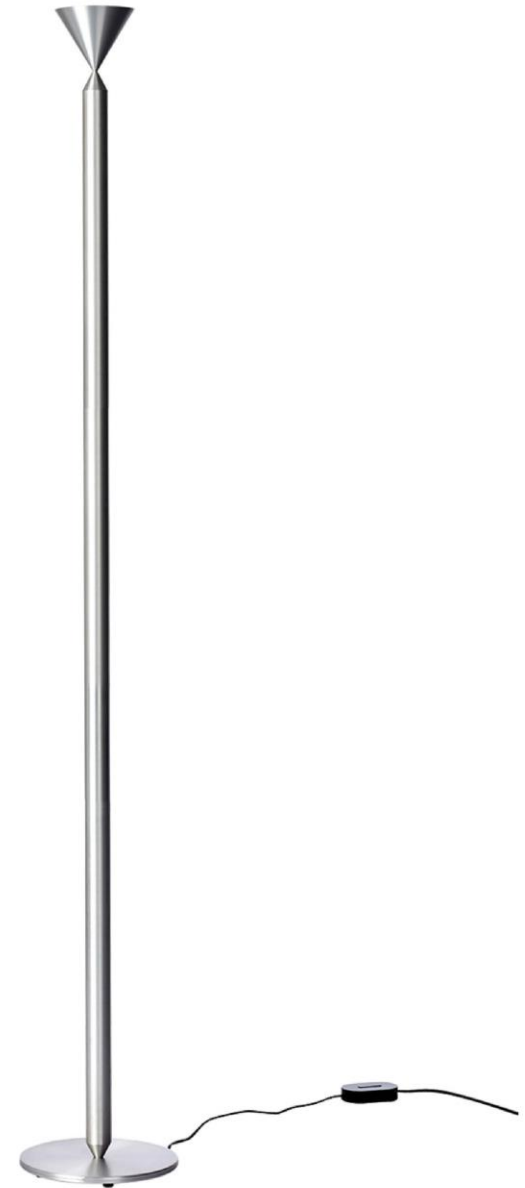

LIMITED EDITION APOLLO 39, 59 & 79

MOUNTING Ceilingcup

MATERIAL Aluminium, Aluminium / Brass

COLOUR 5 colours

SOCKET G9, Item 292 115 GU10

DIMENSION D:13 H:52

D:13 H:72

D:13 H 92

HOW TO USE Co-working spaces, restaurants
hotel lobbies and other hospitality
spaces. Home setting kitchen or
living room

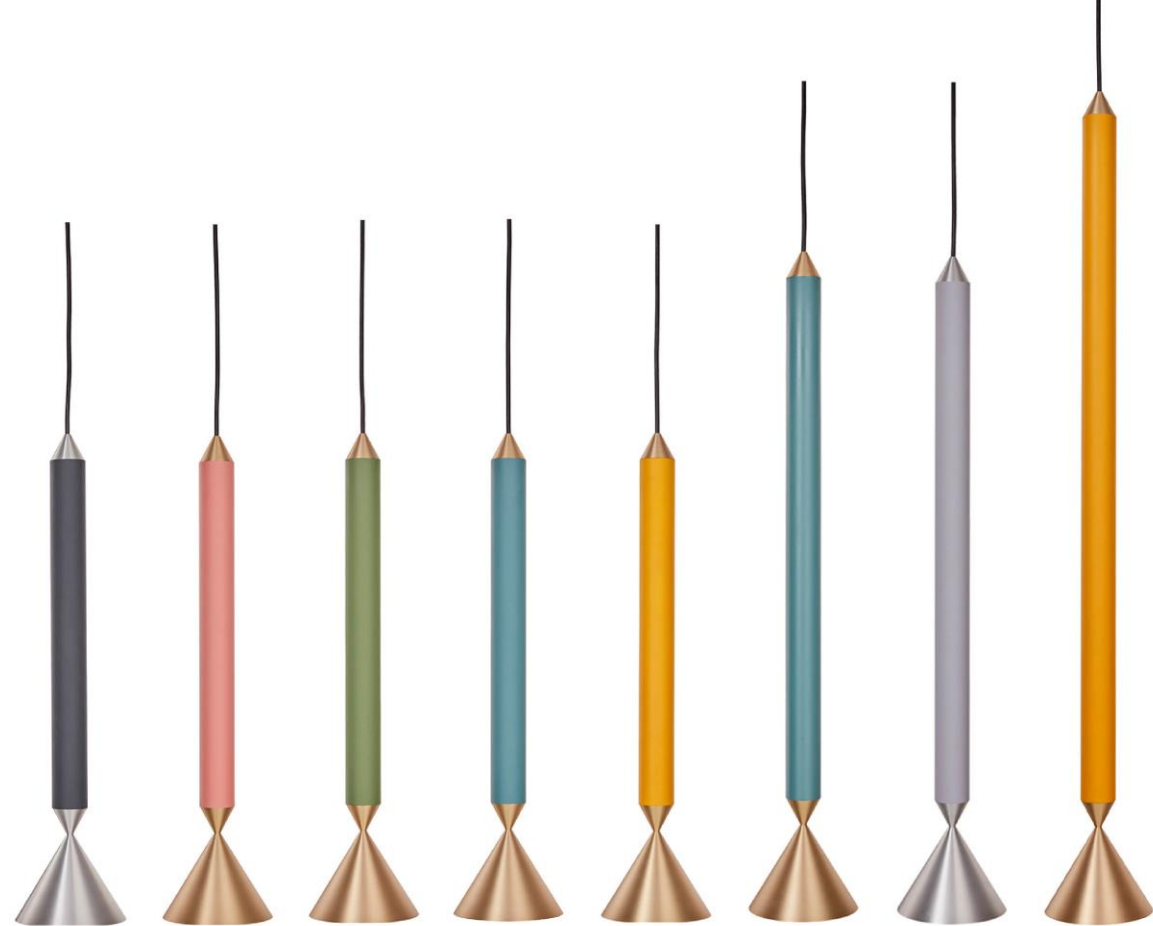

SPECIFICATIONS

DESIGN Broberg & Ridderstråle

MATERIAL Aluminium (base), aluminium/brass (shade)

More information about Apollo 14 wall [\[link\]](#)

More information about Apollo Zero pendant [\[link\]](#)

More information Apollo 180 floor [\[link\]](#)

More information Apollo 39 pendant [\[link\]](#)

More information Apollo 59 pendant [\[link\]](#)

More information Apollo 79 pendant [\[link\]](#)

Download Apollo files [\[link\]](#)





ALINE

A pendant collection

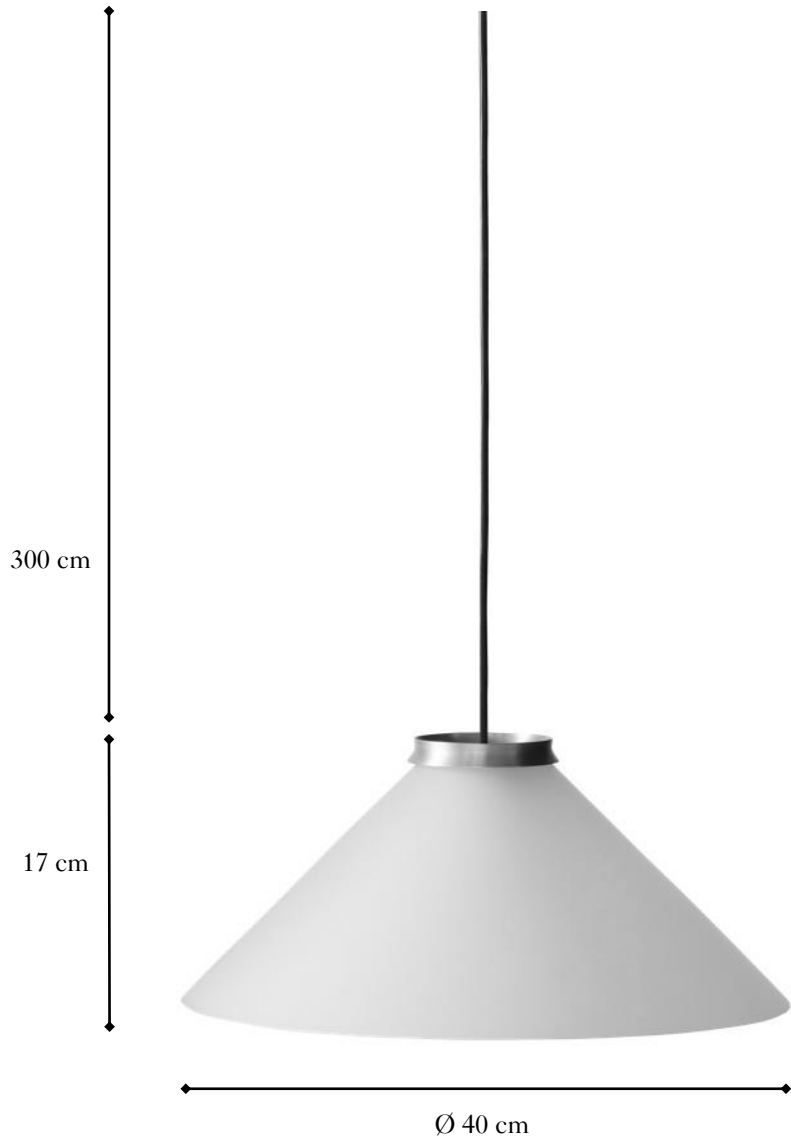

ALINE 40



ALINE 58



FROSTY, ALUMINIUM

FROSTY, BLACK

NCS S 8500-N

FROSTY, COTTON

NCS S 0502-Y

FROSTY, CHAMOMILE

NCS S 1020-G80Y

SPECIFICATIONS

DESIGN *Afterroom*

MATERIAL *Acrylic, aluminium*

More information *Aline 40* [[link](#)]

More information *Aline 58* [[link](#)]

Download *Aline* files [[link](#)]





TURNER

A pendant collection



TURNER 50



TURNER 65



TURNER 80

SPECIFICATIONS

DESIGN Broberg & Ridderstråle

MATERIAL Cocoon, metal

COLOUR Cocoon

More information Turner 50 [\[link\]](#)

More information Turner 65 [\[link\]](#)

More information Turner 80 [\[link\]](#)

Download Turner files [\[link\]](#)





Vol. 2/2

ROMB

A table lamp collection

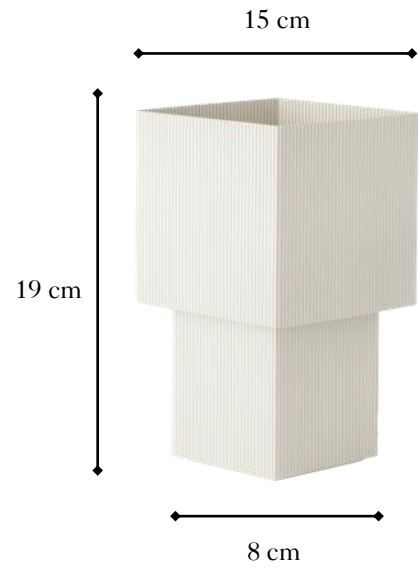

**ROMB MINI
(RECHARGEABLE)**

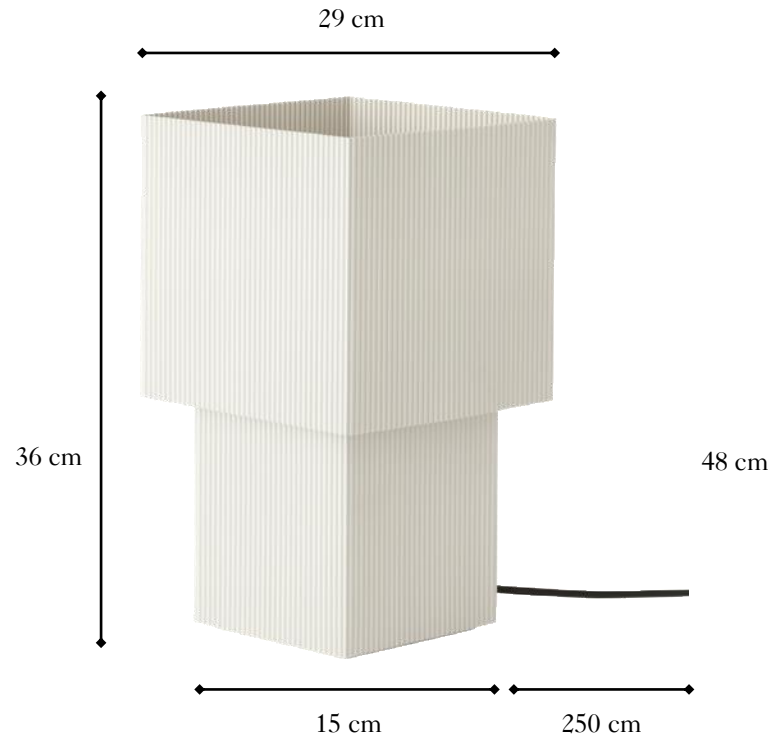

ROMB 36



ROMB 48

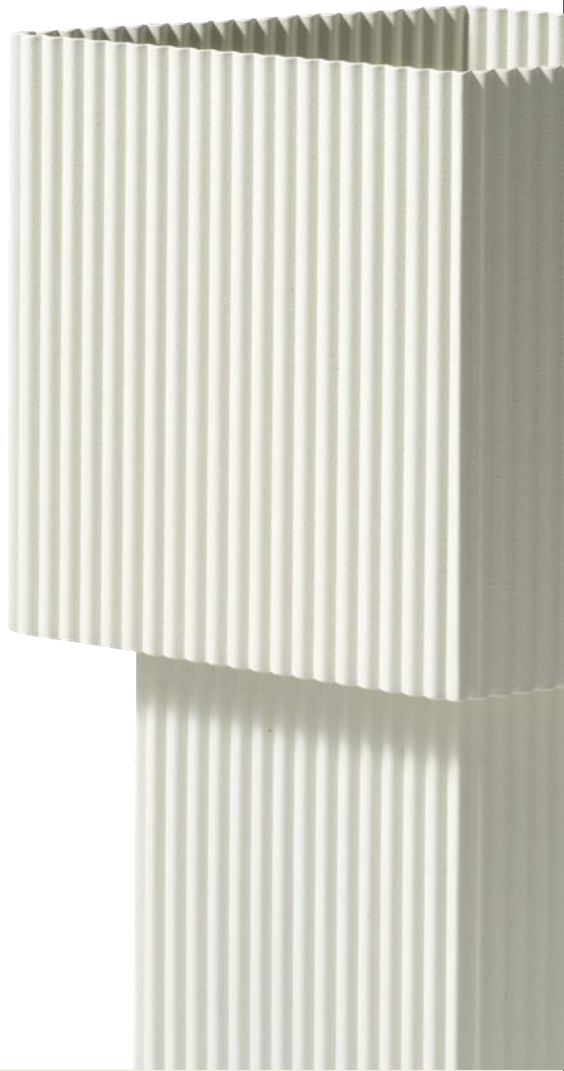

COTTON
NCS S 0502-Y

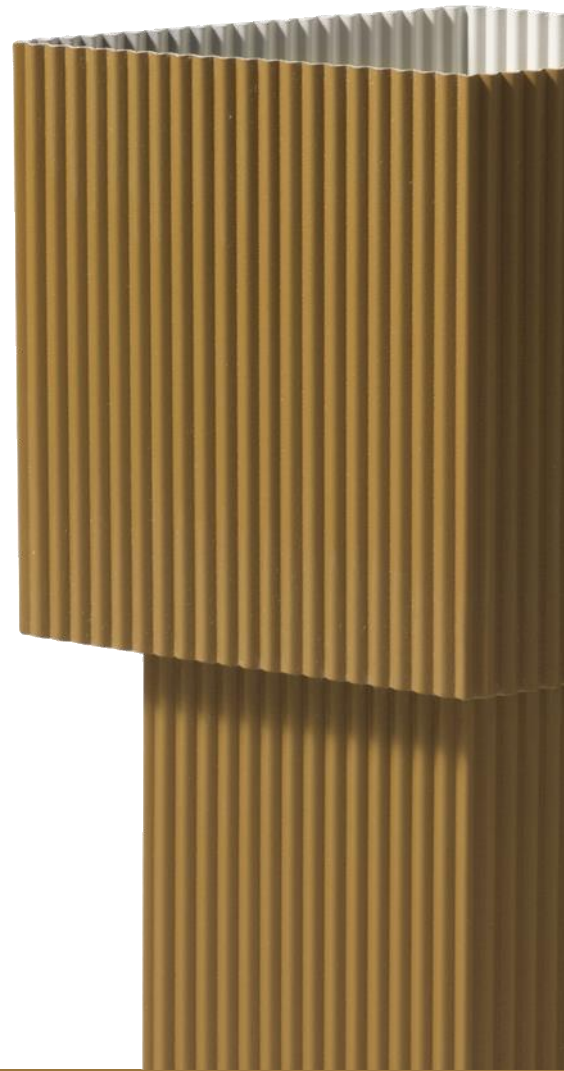

CUMIN
NCS S 4040-YR0R



BLUE STONE
NCS S 6010-R90B
Exclusively for Romb Mini

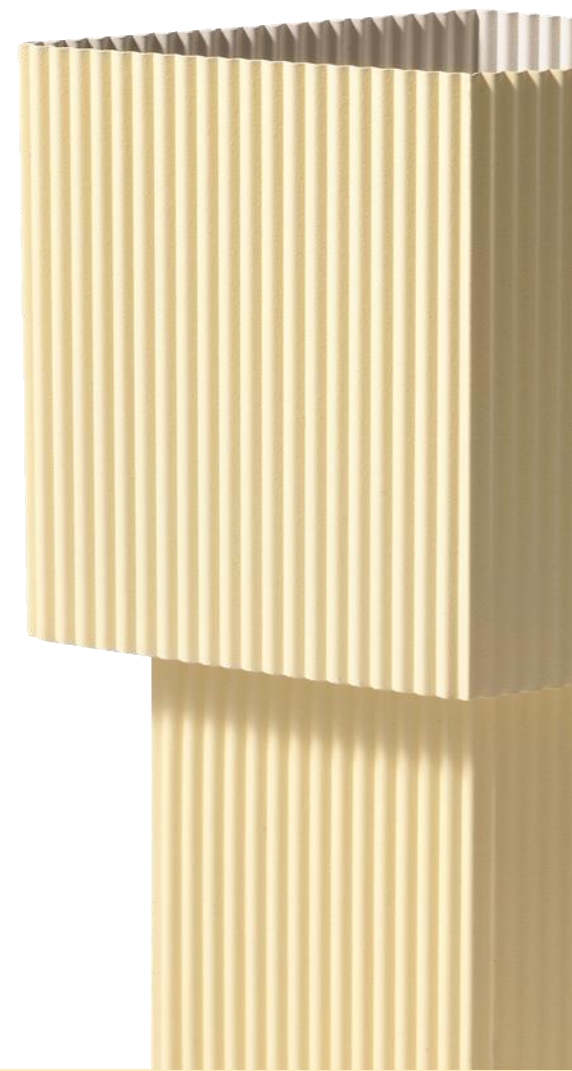

VANILLA
NCS S 0515-Y
Exclusively for Romb Mini

SPECIFICATIONS

DESIGN Broberg & Ridderstråle

MATERIAL Metal

More information Romb Mini [\[link\]](#)

More information Romb 36 [\[link\]](#)

More information Romb 48 [\[link\]](#)

Download Romb files [\[link\]](#)

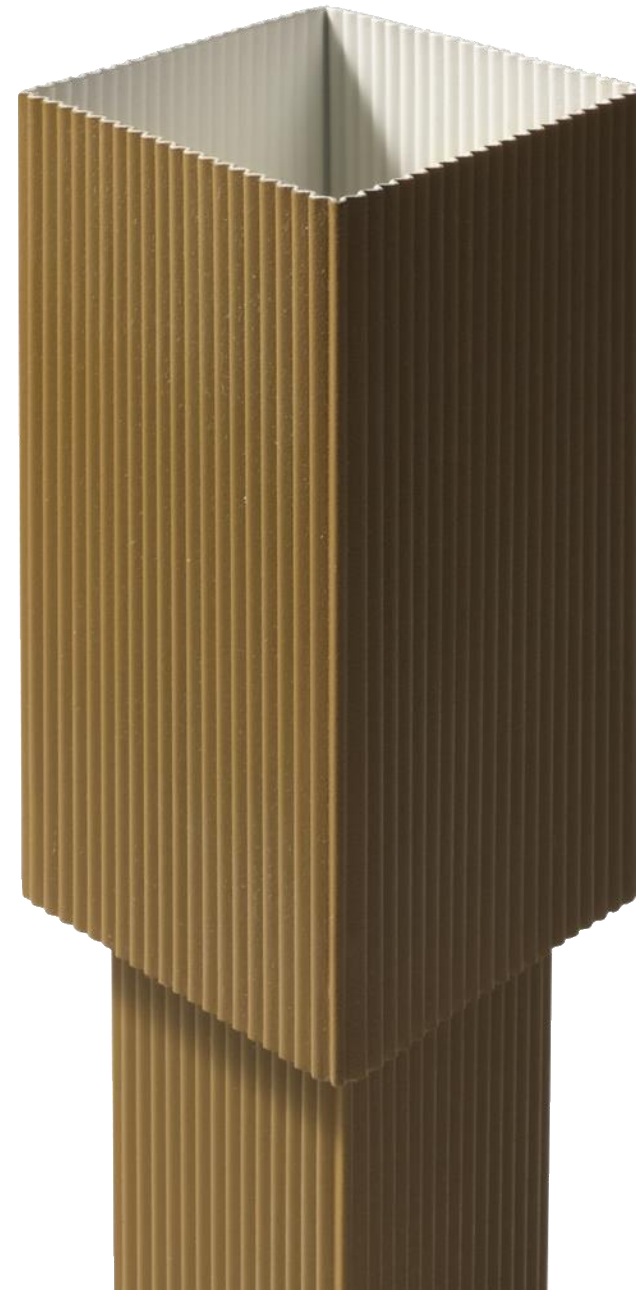



DONNA

A pendant and wall lamp collection

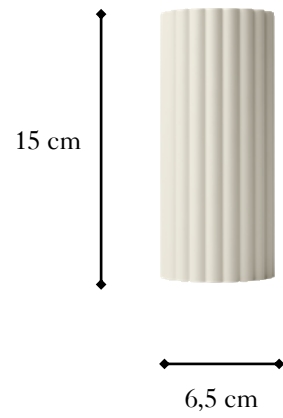

DONNA 15



DONNA 18

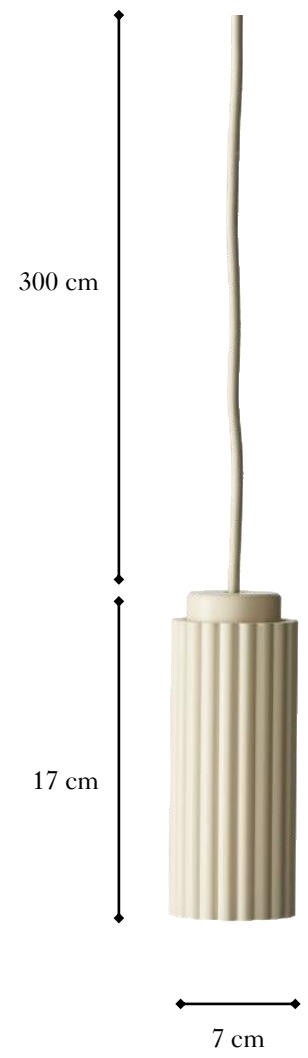

DONNA 7

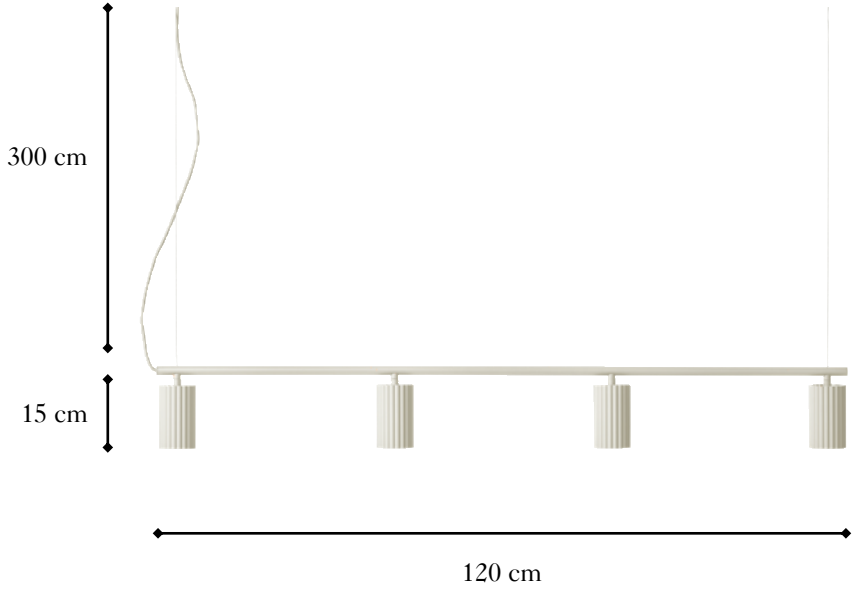

DONNA LINE 120

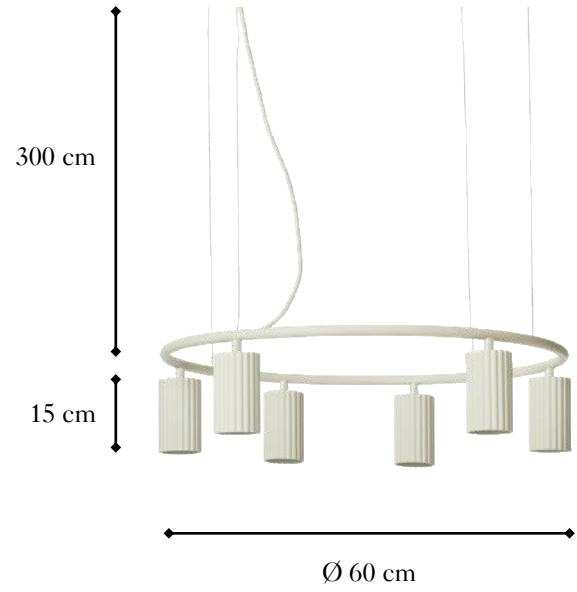

DONNA CIRCLE 60

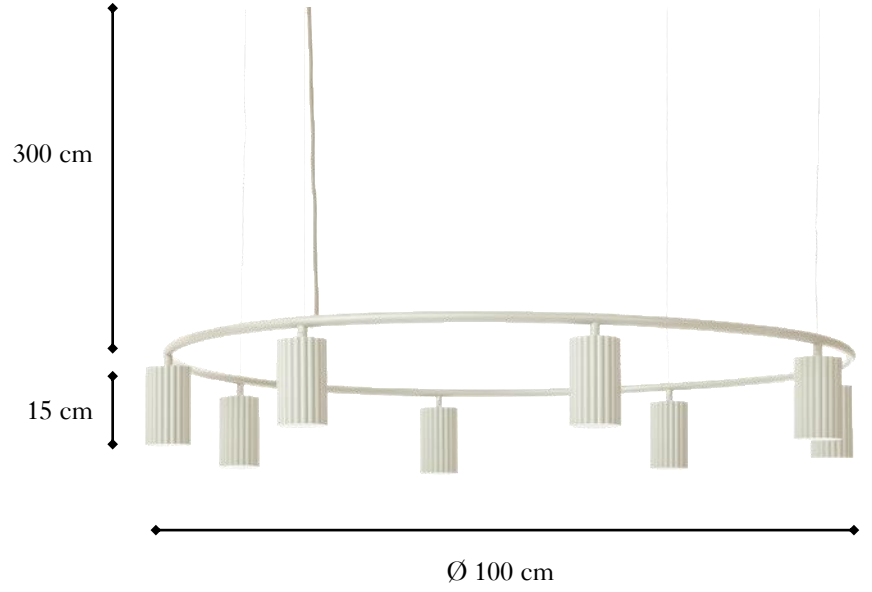

DONNA CIRCLE 100



BLACK INK

NCS S 7502-B



LINEN

NCS S 1005-Y



AUTUMN LEAVES

NCS S 3030-Y10R
Exclusively for Donna 7, 15, 18 &
Donna Line 120



BLUSH

NCS S 3020-Y60R
Exclusively for Donna 7, 15, 18 &
Donna Line 120



AMBER GREEN

NCS S 4040-G90Y

Exclusively for Donna 7 & 15



CHESTNUT

NCS S 8010-Y50R

Exclusively for Donna 7 & 15



MIDNIGHT BLUE

NCS S 6020-R90B

Exclusively for Donna 7 & 15

SPECIFICATIONS

DESIGN Nina Jobs and Stina Sandwall

MATERIAL Aluminium

More information Donna 7 [\[link\]](#)

More information Donna 15 [\[link\]](#)

More information Donna 18 [\[link\]](#)

More information Donna Circle 60 [\[link\]](#)

More information Donna Circle 100 [\[link\]](#)

More information Donna Line 120 [\[link\]](#)

Download Donna files [\[link\]](#)

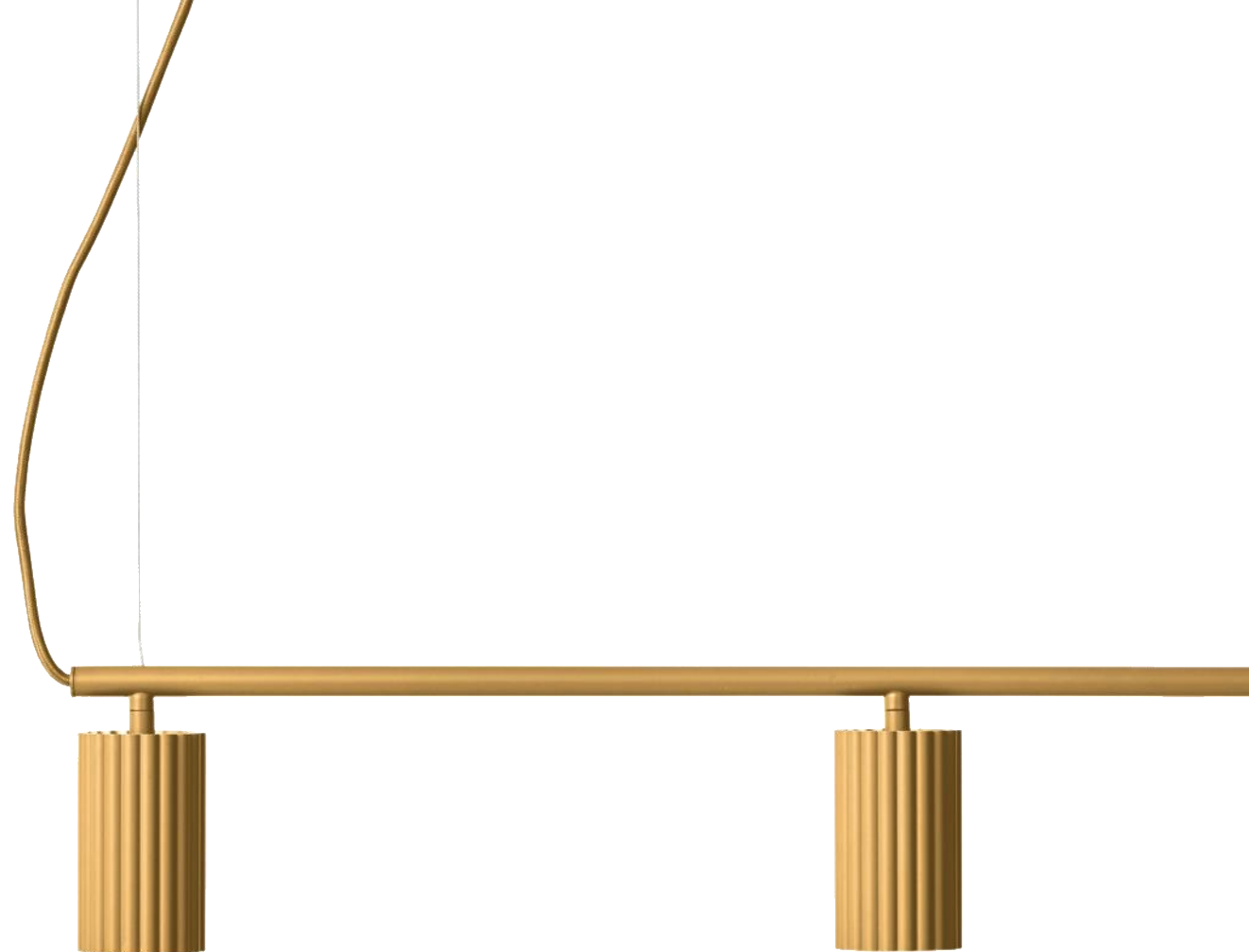



KANDINSKY

A pendant collection

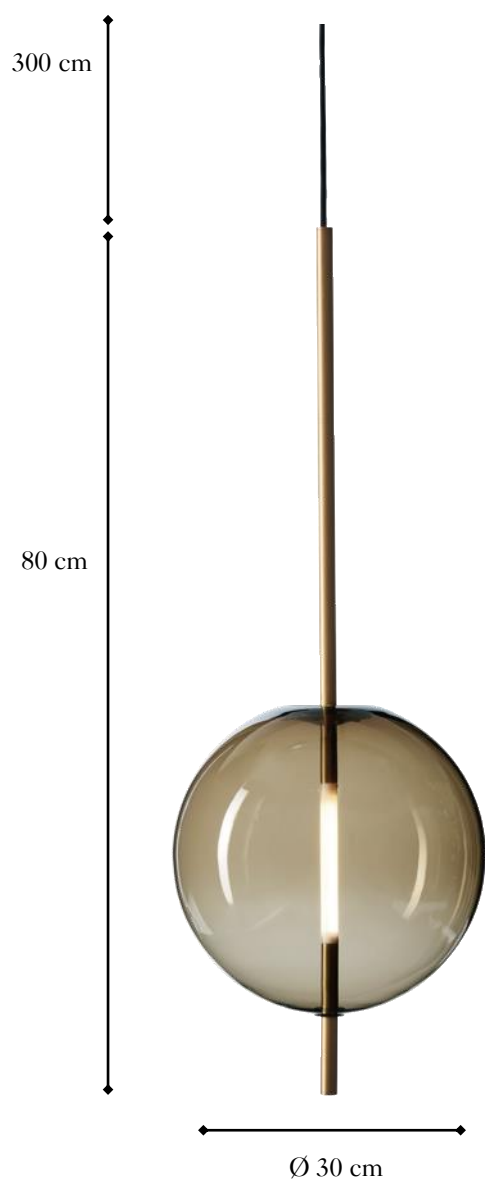

KANDINSKY 30



KANDINSKY 45



SMOKED BROWN, BRASS



SMOKED GREY, BRASS

SPECIFICATIONS

DESIGN Broberg & Ridderstråle

MATERIAL Glass, brass

More information Kandinsky 30 [\[link\]](#)

More information Kandinsky 45 [\[link\]](#)

Download Kandinsky files [\[link\]](#)



BOUNCE

A pendant collection



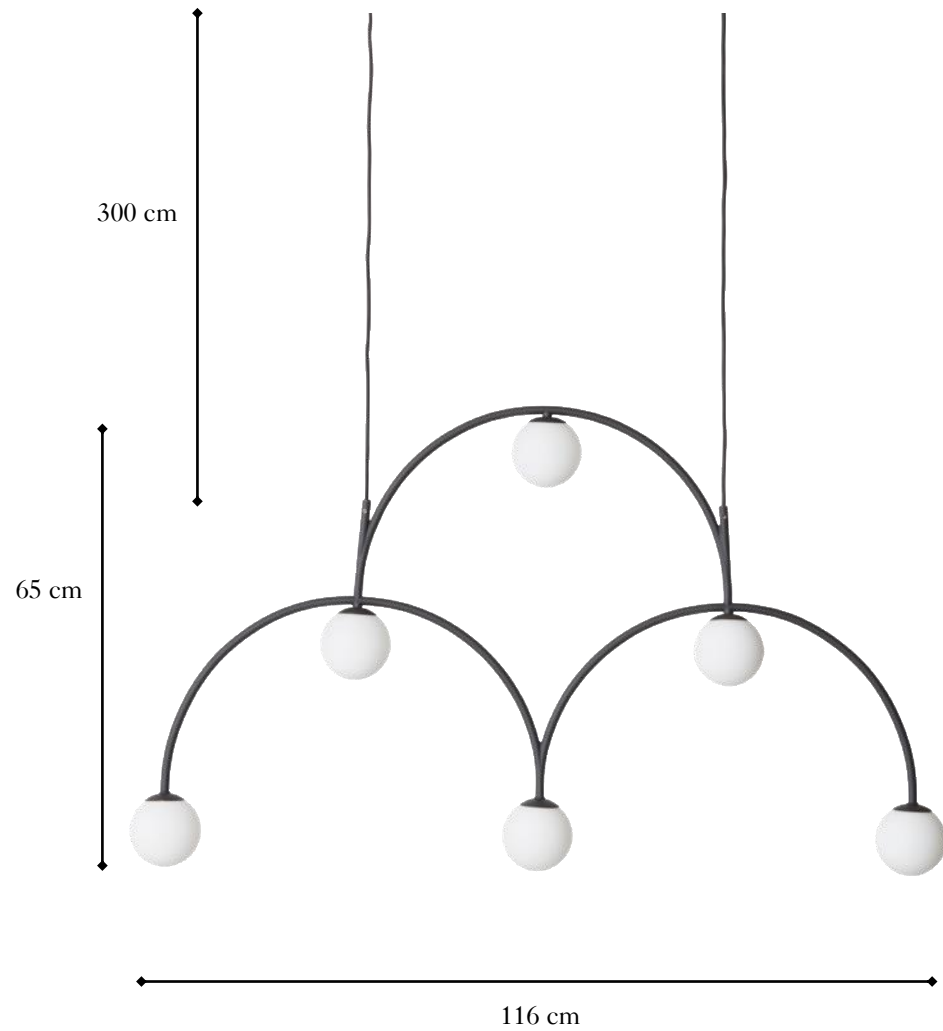

BOUNCE 116

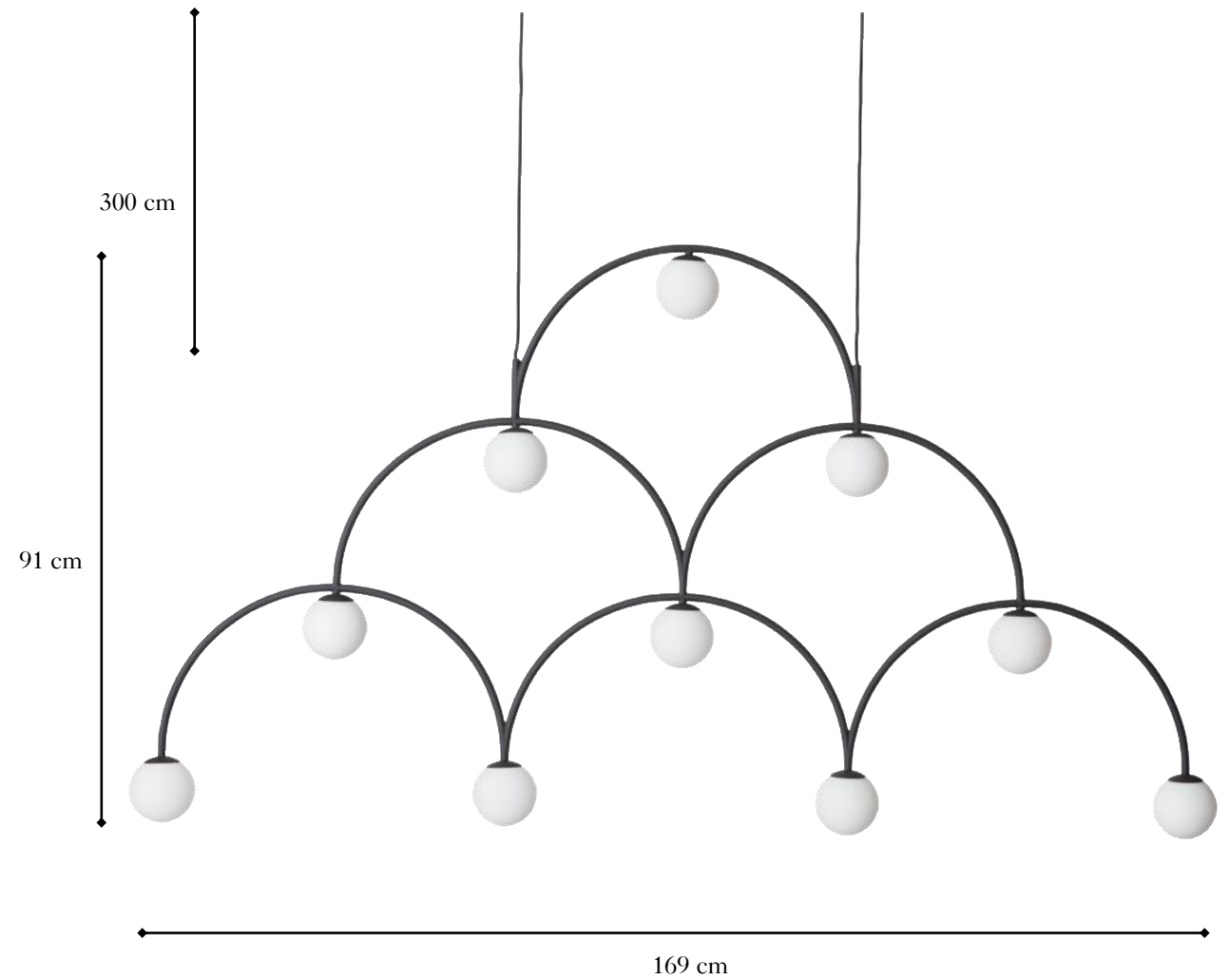

BOUNCE 169

SPECIFICATIONS

DESIGN Monika Mulder

MATERIAL Metal, glass

COLOUR Black, opal

More information Bounce 116 [[link](#)]

More information Bounce 169 [[link](#)]

Download Bounce files [[link](#)]





MOBIL

A pendant, wall and table lamp collection

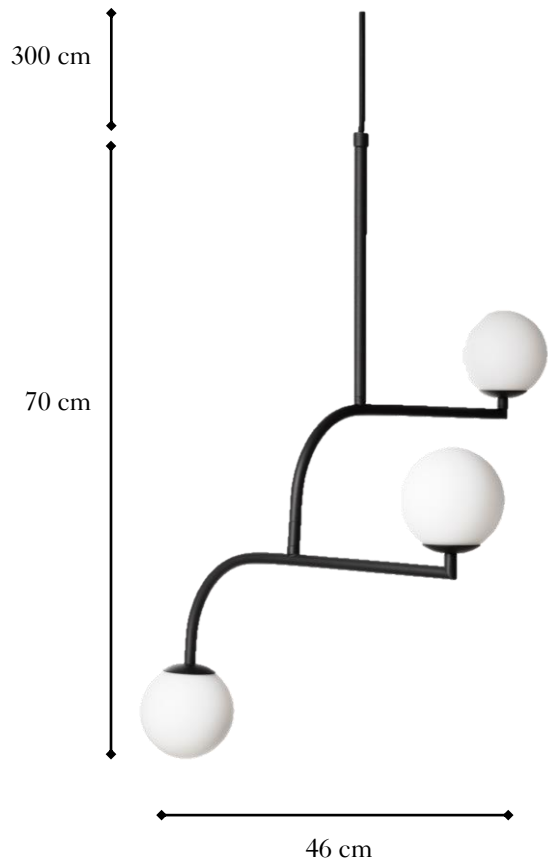

MOBIL 70

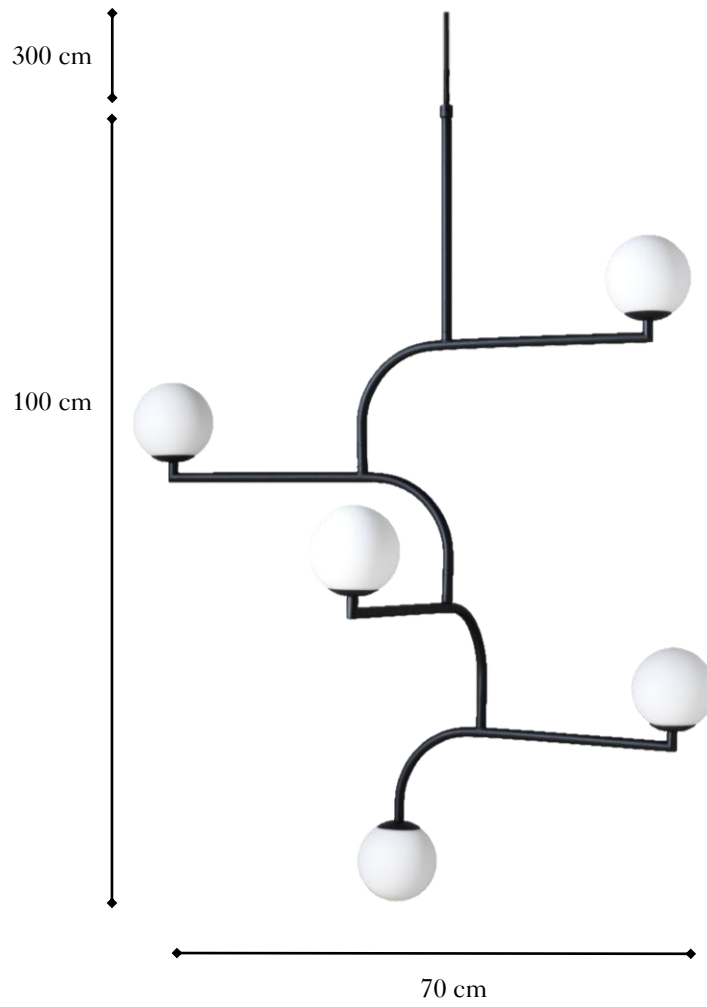

MOBIL 100

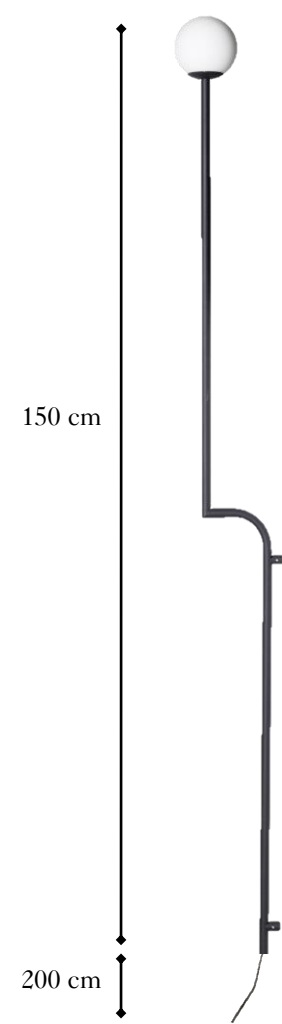

MOBIL 150



MOBIL 12

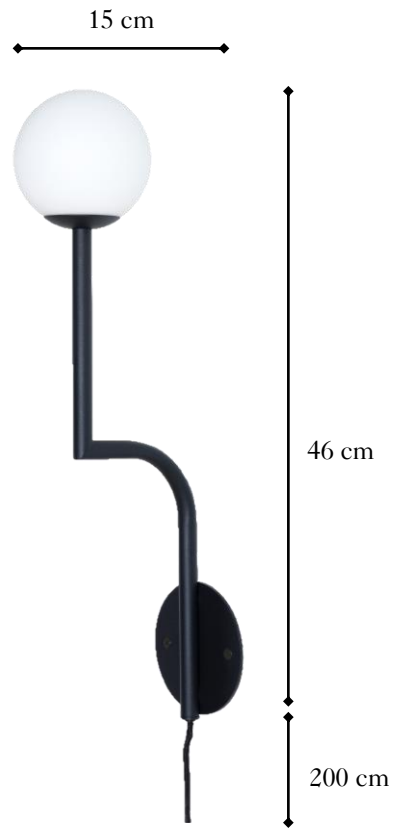

MOBIL 46

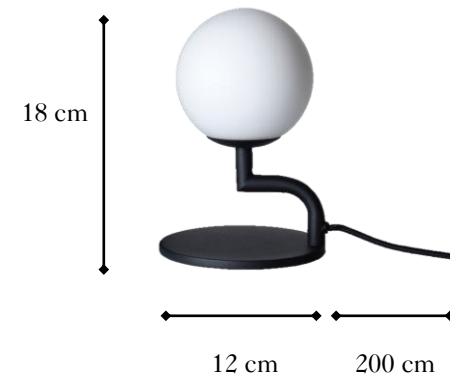

MOBIL 18



BLACK, OPAL

NCS S 8500-N



BRASS, OPAL

Exclusively for Mobil 12, 18, 46, 70 & 100



NICKEL, OPAL

Exclusively for Mobil 70 & 100

SPECIFICATIONS

DESIGN Monika Mulder

MATERIAL Metal/brass, glass

More information Mobil 12 [[link](#)]

More information Mobil 18 [[link](#)]

More information Mobil 46 [[link](#)]

More information Mobil 70 [[link](#)]

More information Mobil 100 [[link](#)]

More information Mobil 150 [[link](#)]

Download Mobil files [[link](#)]



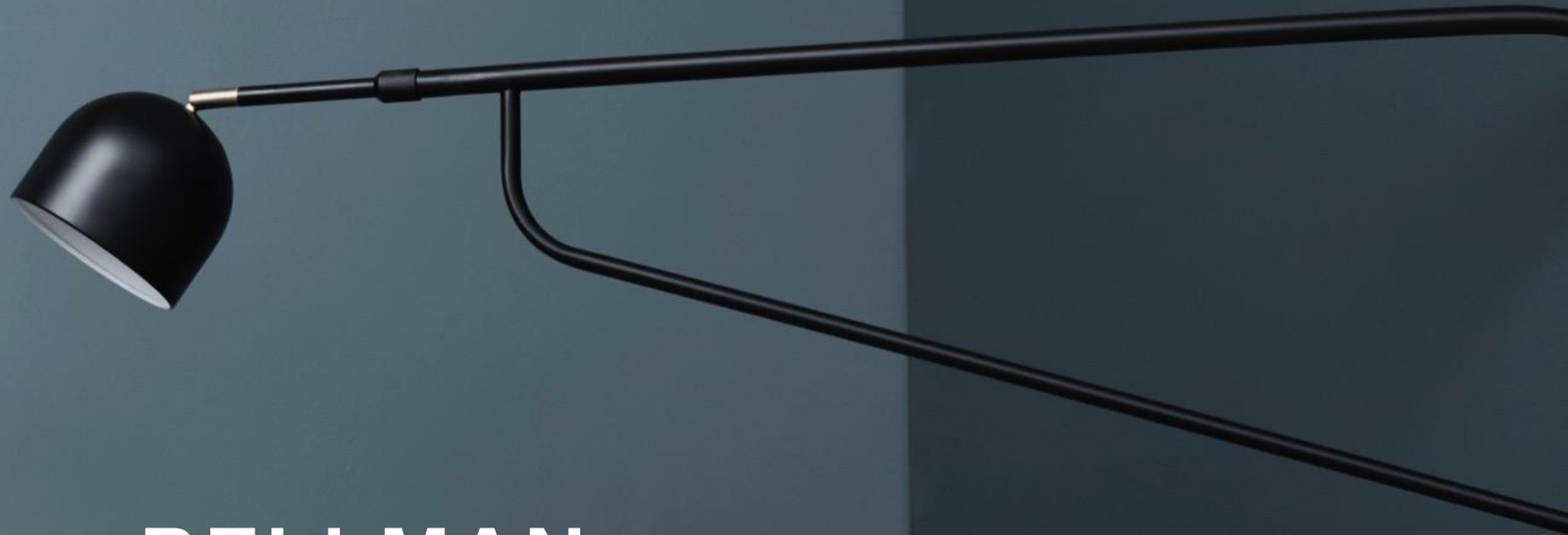

BELLMAN

A wall lamp collection

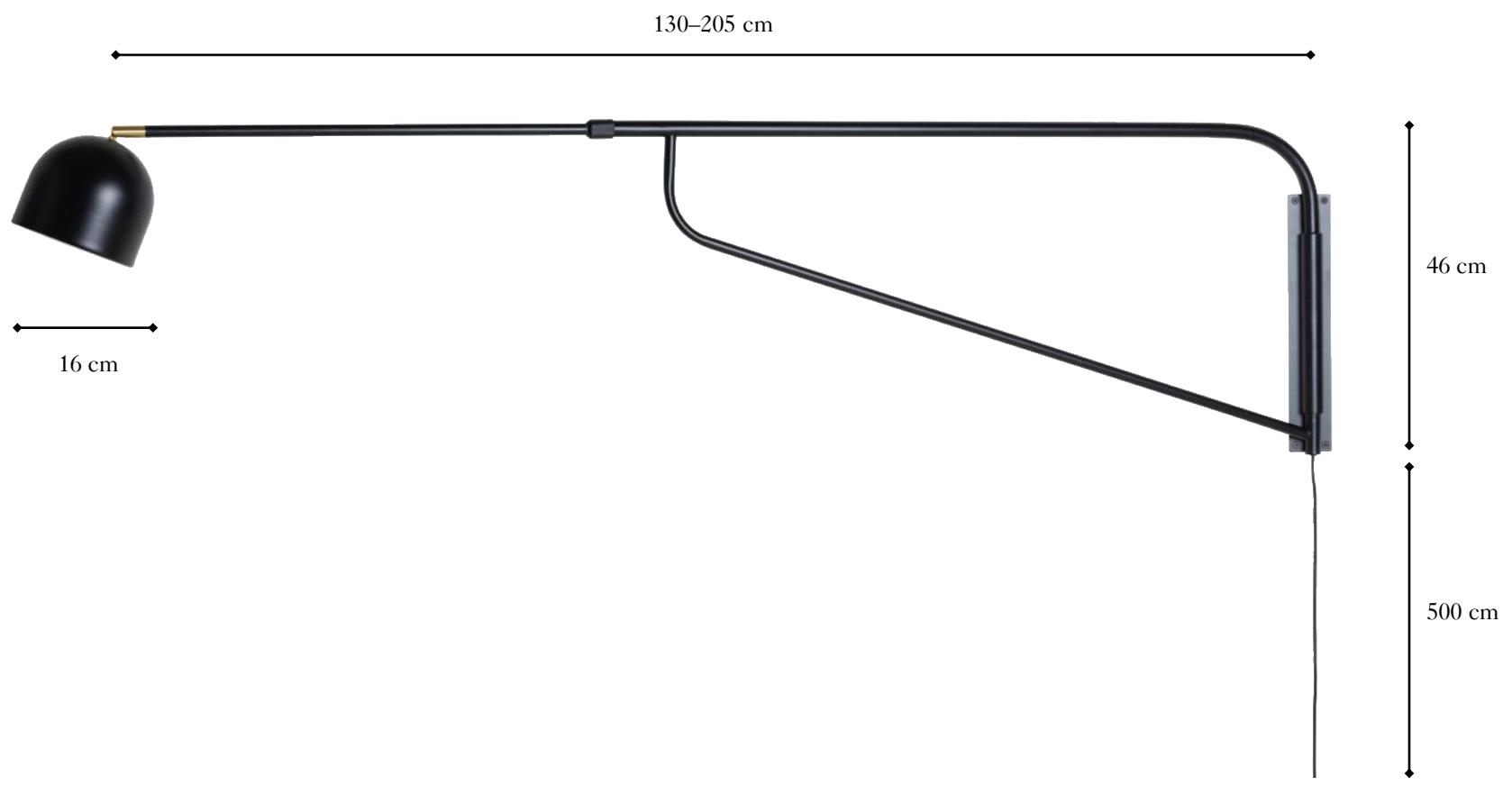

BELLMAN 205



JET BLACK

NCS S 9000-N



WHITE PORCELAIN

NCS S 0502-G50Y



SPECIFICATIONS

DESIGN Sabina Grubbesson

MATERIAL Metal

More information Bellman 205 [[link](#)]

Download Bellman files [[link](#)]



BLEND

A pendant, ceiling and floor lamp collection

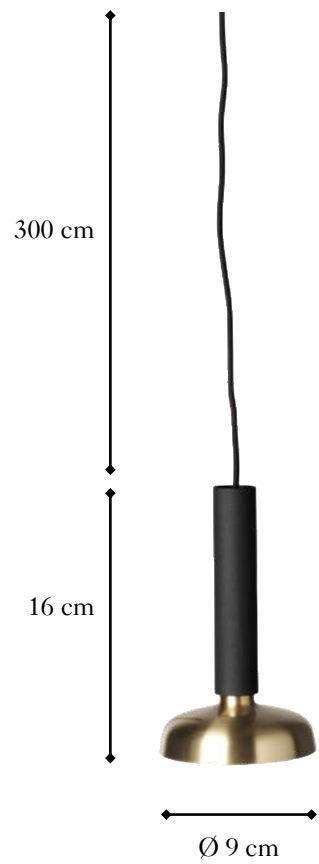

BLEND 9

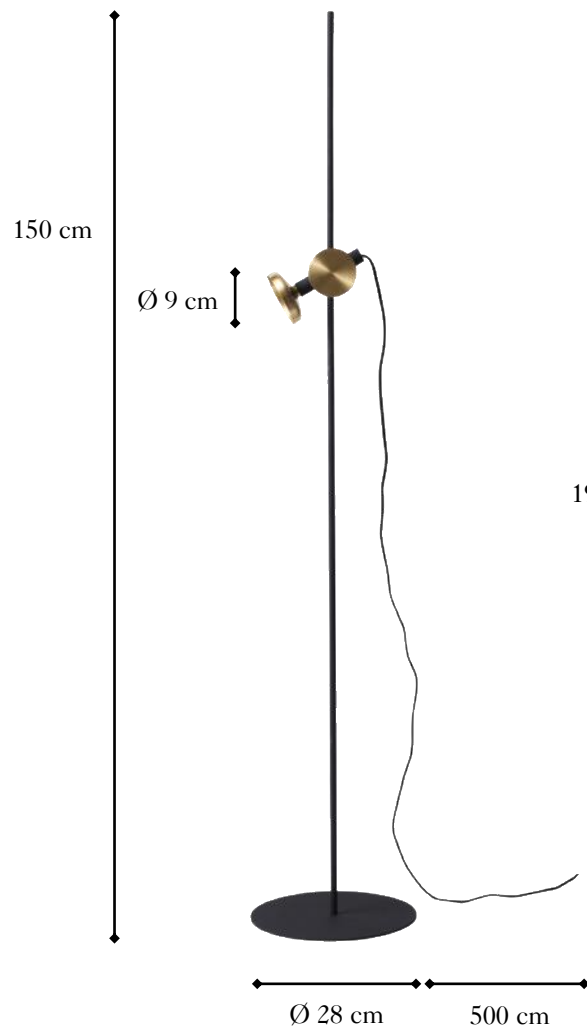

BLEND 150

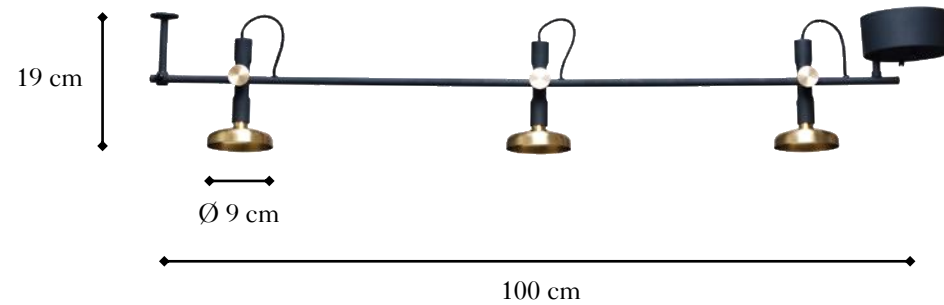

BLEND 100



JET BLACK, BRASS

NCS S 9000-N



FOREST, BRASS

NCS S 5020-G30Y

Exclusively for Blend 9



TRAFFIC WHITE, BRASS

NCS S 0500-N

Exclusively for Blend 9 & 150

SPECIFICATIONS

DESIGN Sabina Grubbesson

MATERIAL Metal, brass

More information Blend 9 [[link](#)]

More information Blend 100 [[link](#)]

More information Blend 150 [[link](#)]

Download Blend files [[link](#)]

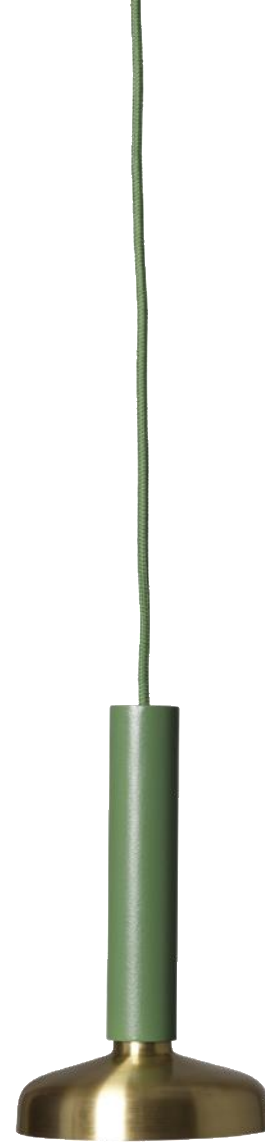



PEARLS

A pendant collection

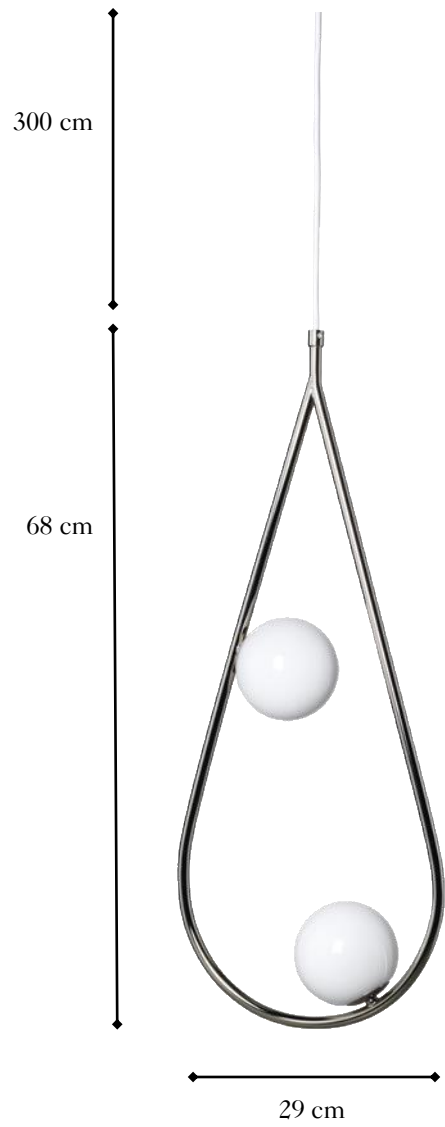

PEARLS 65

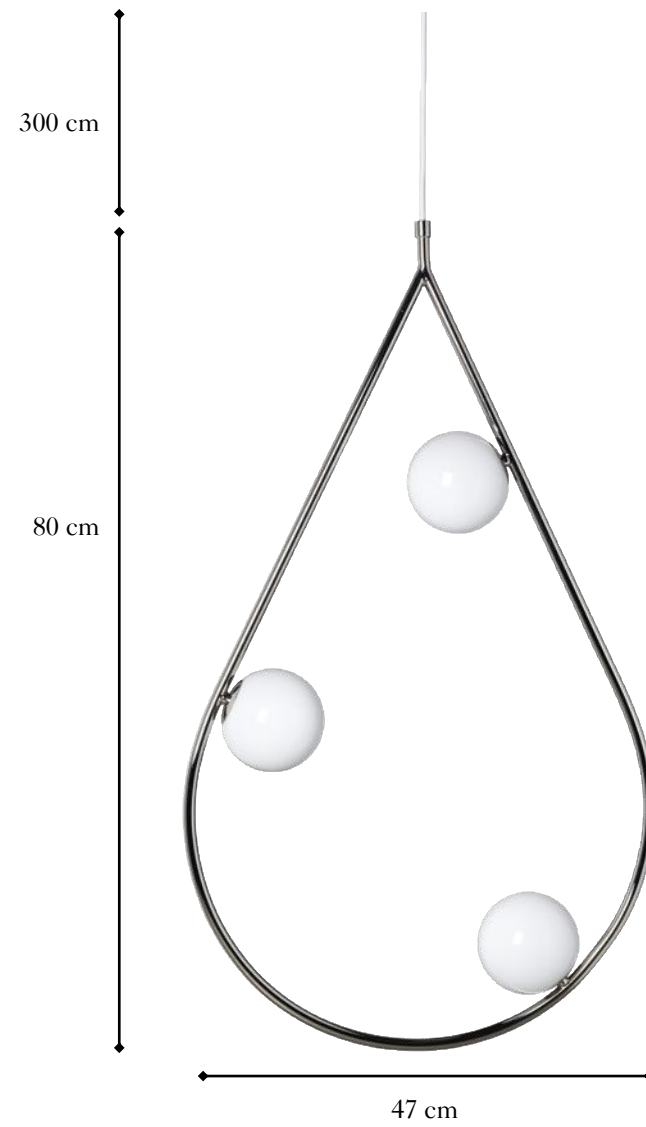

PEARLS 80



BRASS, OPAL



NICKEL, OPAL

SPECIFICATIONS

DESIGN Monika Mulder

MATERIAL Brass/metal, glass

More information Pearls 65 [\[link\]](#)

More information Pearls 80 [\[link\]](#)

Download Pearls files [\[link\]](#)





HANS

A pendant, table and floor lamp collection

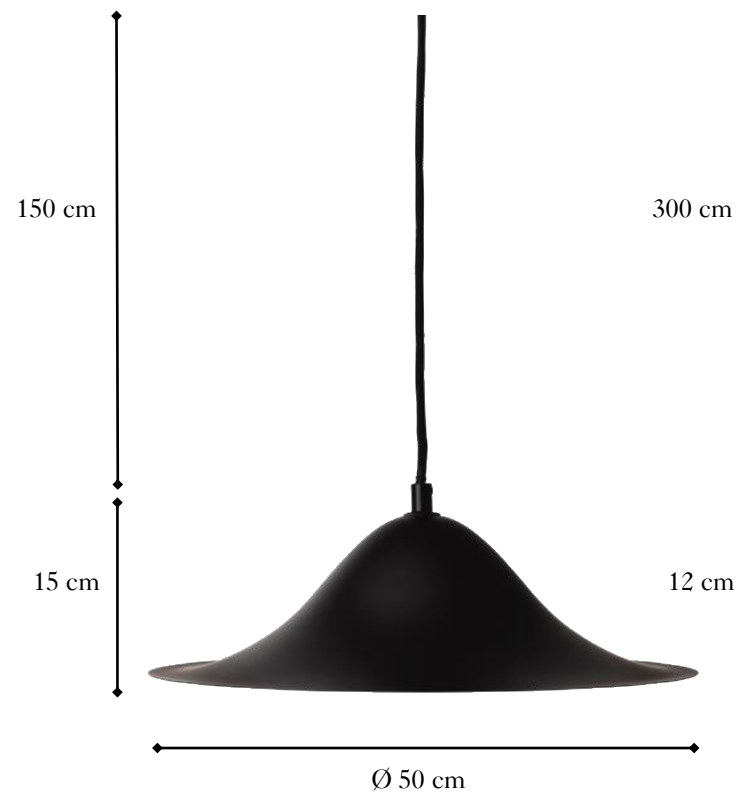

HANS 50

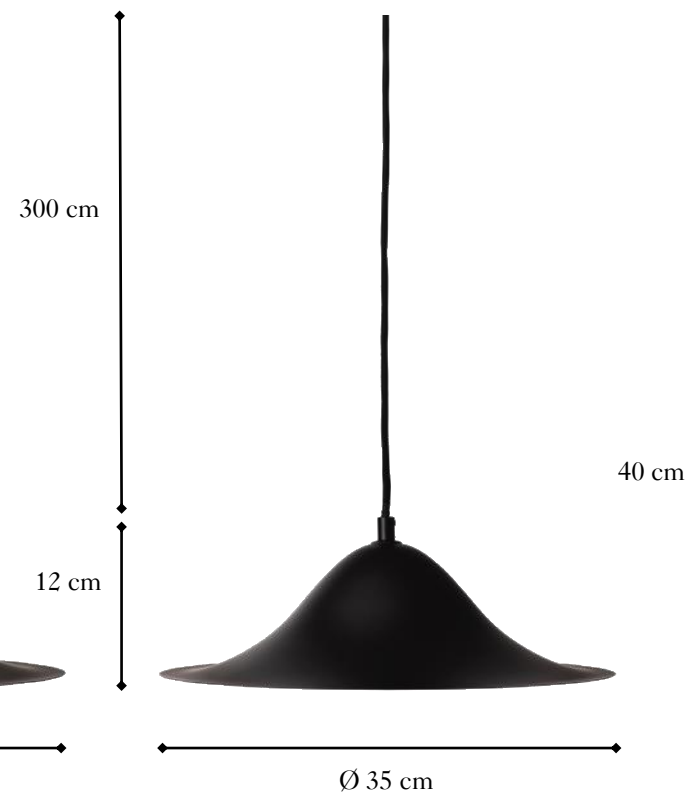

HANS 35

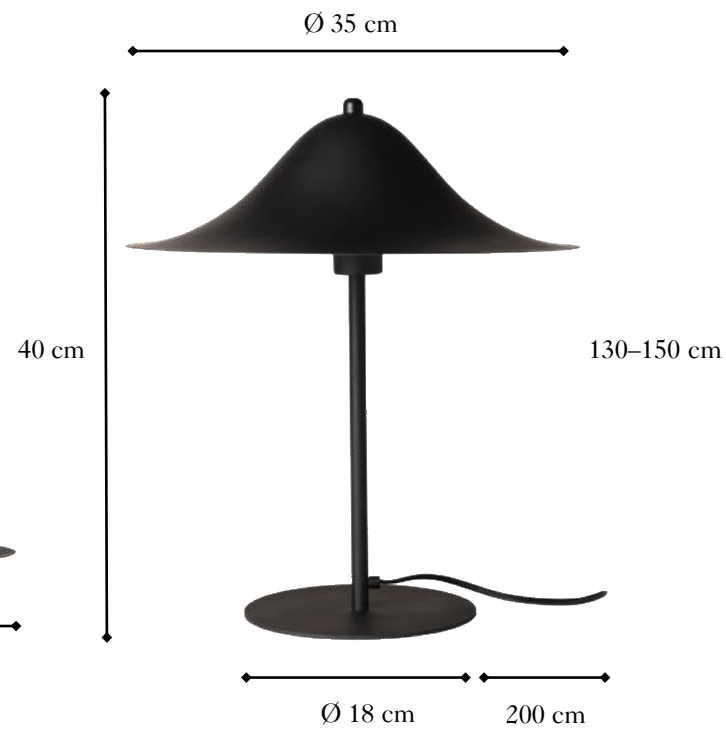

HANS 40

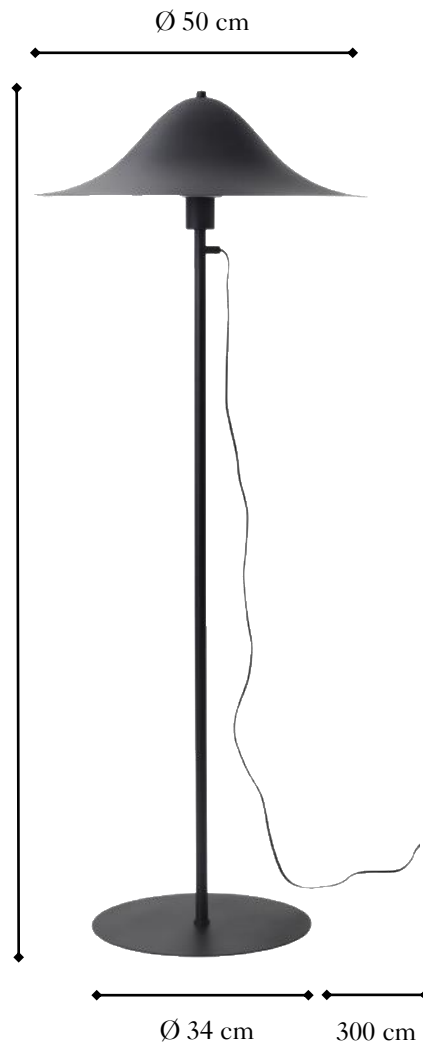

HANS 130



BLACK
NCS S 8500-N



WHITE PROCELAIN
NCS S 0502-G50Y
Exclusively for Hans 50

SPECIFICATIONS

DESIGN Monika Mulder

MATERIAL Aluminium

More information Hans 35 [[link](#)]

More information Hans 40 [[link](#)]

More information Hans 50 [[link](#)]

More information Hans 130 [[link](#)]

Download Hans files [[link](#)]



CHAMPAGNE

A pendant and table lamp collection



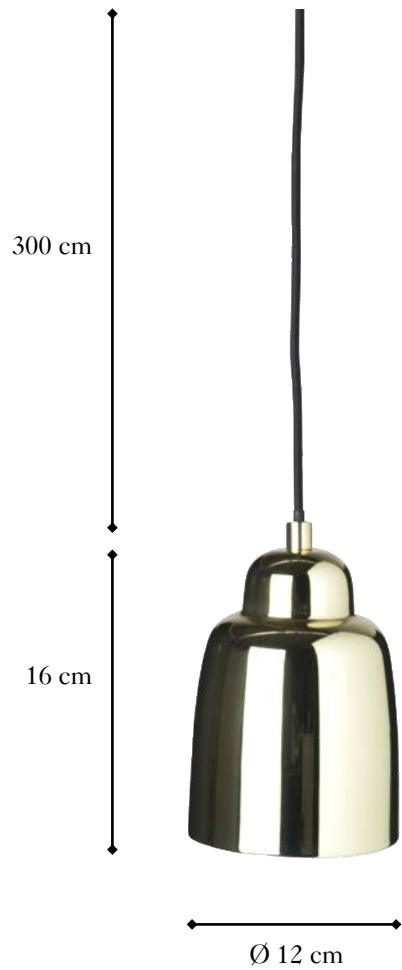

CHAMPAGNE 12



CHAMPAGNE 30

SPECIFICATIONS

DESIGN	Monika Mulder
MATERIAL	Metal
COLOUR	Shiny gold finish (Champagne 12), Brushed gold finish (Champagne 30)

More information Champagne 12 [[link](#)]

More information Champagne 30 [[link](#)]

Download Champagne files [[link](#)]



Proudly Distributed by



For US Distribution, please contact IM Design Concepts

imdesignconcepts.com | info@imdesignconcepts.com | (813) 284-7435

pholc